

MEGAPIX® IP Cameras

5MP models	21MP/1080P models
DWC-MF5Wi4TW	DWC-MF2Wi4T
DWC-MF5Wi6TW	DWC-MF2Wi4TW
DWC-MF5Wi8TW	DWC-MF2Wi28TW

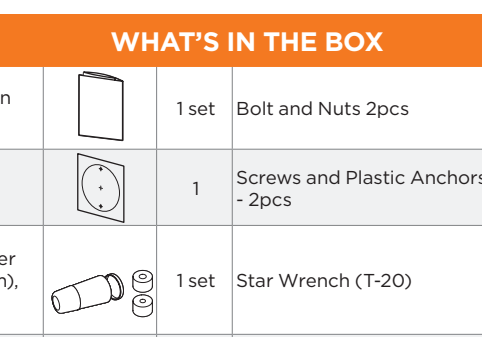

Default Login Information: admin | admin

When logging into the camera for the first time, you will be prompted to set up a new password. You can set the new password using the DW® IP Finder™ software or directly from the camera's browser menu.

WHAT'S IN THE BOX

Quick Setup and Installation Guide		1 set	Bolt and Nuts 2pcs		1 set
Mounting Templates		1	Screws and Plastic Anchors - 2pcs		1 set
Waterproof Cap and Rubber Rings (Black: ø0.15" (ø4mm), White: ø0.19" (ø5mm))		1 set	Star Wrench (T-20)		1
Moisture absorber and installation guide (recommended)		1 set			

NOTE: Download all your support materials and tools in one place

- Go to <http://www.digital-watchdog.com/resources>
- Search your product by entering the part number in the "Search by Product" search bar. Results for applicable part numbers will populate automatically based on the part number you enter.
- Click "Search". All supported materials, including manuals and quick start guide (QSGs) will appear in the results.

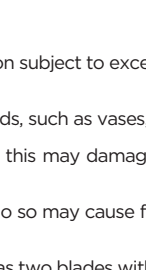

Attention: This document is intended to serve as a quick reference for the initial set-up. It is recommended that the user read the entire instruction manual for complete and proper installation and usage.

SAFETY AND WARNING INFORMATION

Read through this Installation Guide carefully before installing the product. Keep the Installation Guide for future reference. See the user manual for more information on the proper installation, use and care of the product. These instructions are intended to ensure that users can use the product correctly to avoid danger or property loss. Warnings: Serious injury or death may occur if any of the warnings are neglected. Cautions: Injury or equipment damage may occur if any of the cautions are neglected.

WARNING

- In the use of the product, you must be strict compliance with the electrical safety regulations of the nation and region. When the product is mounted on a wall or ceiling, the device shall be firmly fixed.
- Be sure to use only the standard adapter specified in the specification sheet. Using any other adapter could cause fire, electrical shock, or damage to the product.
- Make sure the power supply voltage is correct before using the camera.
- Incorrectly connecting the power supply or replacing the battery may cause an explosion, fire, electric shock, or damage to the product.
- Do not connect multiple cameras to a single adapter. Exceeding the capacity may cause excessive heat generation or fire.
- Do not place conductive objects (e.g. screwdrivers, coins, metal items, etc.) or containers filled with water on top of the camera. Doing so may cause personal injury due to fire, electric shock, or falling objects.
- When installing the camera, fasten it securely and firmly. A falling camera may cause personal injury.
- Do not install in a location subject to elevated temperature, low temperature, or high humidity. Doing so may cause fire or electric shock.
- Do not place conductive objects (e.g. screwdrivers, coins, metal items, etc.) or containers filled with water on top of the camera. Doing so may cause personal injury due to fire, electric shock, or falling objects.
- Do not install in humid, dusty, or sooty locations. Doing so may cause fire or electric shock.
- Do not install near any heat sources such as radiators, heat registers, or other products (including amplifiers) that produce heat.
- Keep out of direct sunlight and heat radiation sources. It may cause a fire.
- If any unusual smells or smoke come from the unit, stop using the product at once. Immediately disconnect the power source and contact the service center. Continued use in such a condition may cause fire or electric shock. If this product does not operate normally, contact the nearest service center. Never disassemble or change this product in any way.
- When cleaning the product, do not spray water directly onto parts of the product. Doing so may cause fire or electric shock.

CAUTION

- Use proper safety gear when installing and wiring the product.
- Do not drop objects on the product or apply strong shock to it. Keep away from a location subject to excessive vibration or magnetic interference.
- Do not use this product near water.
- The product shall not be exposed to dripping or splashing and no objects filled with liquids, such as vases, shall be placed on the product.
- Avoid aiming the camera directly towards extremely bright objects such as the sun, as this may damage the image sensor.
- The Main plug is used as a disconnect device and shall stay readily operable at any time.
- Remove the power adapter from the outlet when there is lightning. Neglecting to do so may cause fire or damage to the product.
- Do not block any ventilation openings. Install following the manufacturer's instructions.
- A polarized or grounding-type plug is recommended for this product. A polarized plug has two blades with one wider than the other. A grounding-type plug has two blades and a third grounding prong. If the provided plug does not fit into your outlet, consult an electrician for replacement.
- Protect the power cord from being walked on or pinched particularly at plugs, convenience receptacles, and the point where they exit from the product.
- If any laser equipment is used near the product, make sure the surface of the sensor is not exposed to the laser beam as that may damage the sensor module.
- If you want to move the already installed product, be sure to turn off the power and then move or reinstall it.
- Proper configuration of all passwords and other security settings is the responsibility of the installer and/or end-user.
- If cleaning is necessary, please use a clean cloth to wipe it gently. If the device will not be used for a long time, please cover the lens cap to protect the device from dirt.
- Use only attachments/accessories specified by the manufacturer.
- Always use hardware (e.g. screws, anchors, bolts, locking nuts, etc.) compatible with the mounting surface and of sufficient length and construction to ensure a secure mount.
- Use only with cart, stand, tripod, bracket, or table specified by the manufacturer, or sold with the product.
- Unplug this product when a cart is used. Use caution when moving the cart/product combination to avoid injury from a tip-over.
- Refer all servicing to qualified service personnel. Servicing is needed when the product has been damaged in any way, such as power supply cord or plug is damaged, liquid has been spilled or objects have fallen into the product, the product has been exposed to rain or moisture, does not operate normally, or has been dropped.

STEP 1 - PREPARING TO MOUNT THE CAMERA

- The mounting surface must withstand five times the camera weight.
- Do not let the cables get caught in improper places or the electric line cover can be damaged. This may cause a short or fire.
- CAUTION:** These servicing instructions are for use by qualified service personnel only. To reduce the risk of electric shock do not perform any servicing other than that contained in the operating instructions unless you are qualified to do so.
- This product is intended to be supplied by a UL Listed Power Supply Unit marked "Class 2" or "LPS" or "PS2" and rated 12 Vdc, 0.49A (DWC-MPF5Wi and DWC-MF5Wi series) and 0.33A (DWC-MF2Wi and DWC-MPF2Wi series) min.
- The wired LAN hub providing power over the Ethernet (PoE) in accordance with IEEE 802.3af shall be a UL Listed device with the output evaluated as a Limited Power Source as defined in UL60950-1 or PS2 as defined in UL62368-1.
- Unit is intended for installation in a Network Environment 0 as defined in IEC TR 62102. As such, associated Ethernet wiring shall be limited to inside the building.
- For the installation process, remove the dome cover from the camera module by loosening the three (3) screws on the dome. Use the wrench provided with the camera.
- Install the moisture packet in the base of the camera's lens.

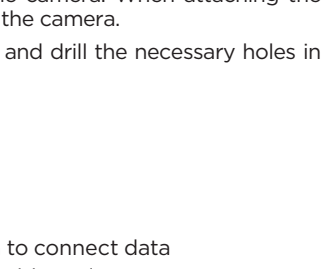

- Remove the moisture absorber from the packaging.
- Cut the card and folder along the dotted line.
- Place the moisture absorber around the camera's lens module.

NOTE: The camera will generate enough heat to dry moisture during operation. In most cases it will not need the moisture absorber for more than the first day. In cases where the camera can experience a moisture issue, users must keep the moisture absorber in the camera. The moisture absorber has an approximately 6-month life cycle, varying depending on the environment.

WARNING: It is highly recommended that you install the moisture absorber when mounting the camera. The moisture absorber prevents moisture from being captured inside the camera's housing, which may cause image performance issues and damage the camera.

- Remove the protective film between the dome and the camera module.
- Remove the Poron Ring before placing the dome back on the camera. When attaching the dome back, align the line on the dome with the one on base of the camera.
- Using the mounting template sheet or the camera itself, mark and drill the necessary holes in the wall or ceiling.

STEP 2 - POWERING THE CAMERA

Pass the wires through and make all necessary connections.

Use a PoE Injector (required. Sold separately) to connect data and power to the camera using a single Ethernet cable.

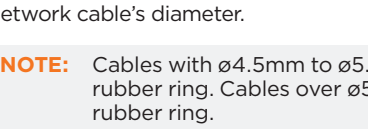

Use non-PoE Switch to connect data and power over an Ethernet cable and use a power adapter to power the camera.

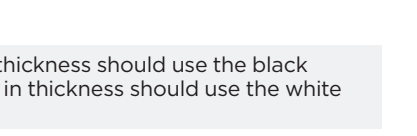

Models	Power requirements	Power consumption
DWC-M(P)F5Wi4TW DWC-M(P)F5Wi6TW DWC-M(P)F5Wi8TW	DC 12V, PoE IEEE 802.3af Class 3. (Adapter not included)	DC12V: max 5.9W PoE: max 7.2W
DWC-M(P)F2Wi4TW DWC-M(P)F2Wi28TW DWC-MF2Wi4T	DC 12V, PoE IEEE 802.3af Class 2. (Adapter not included)	DC12V: max 4W PoE: max 5.5W

WATERPROOF CAP INSTALLATION

The waterproof cap set comes with two rubber rings. Use the rubber ring best sized for your network cable's diameter.

NOTE: Cables with ø4.5mm to ø5.5mm thickness should use the black rubber ring. Cables over ø5.5mm in thickness should use the white rubber ring.

NOTE: To ensure moisture seal, make sure the o-ring is in place between ➊ and ➋. In extreme environments use of an outdoor rated sealer is recommended.

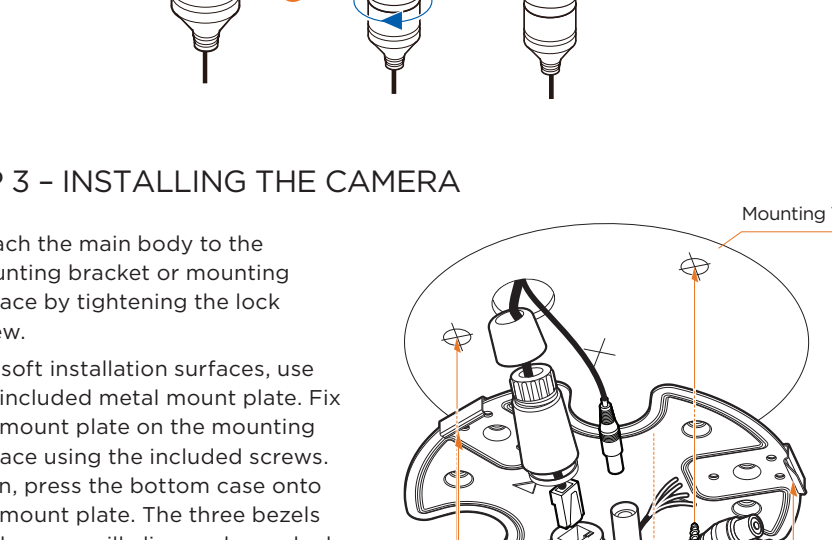

STEP 3 - INSTALLING THE CAMERA

- Attach the main body to the mounting bracket or mounting surface by tightening the lock screw.
- For soft installation surfaces, use the included metal mount plate. Fix the mount plate on the mounting surface using the included screws. Then, press the bottom case onto the mount plate. The three bezels on the case will align and snap lock onto the plate.

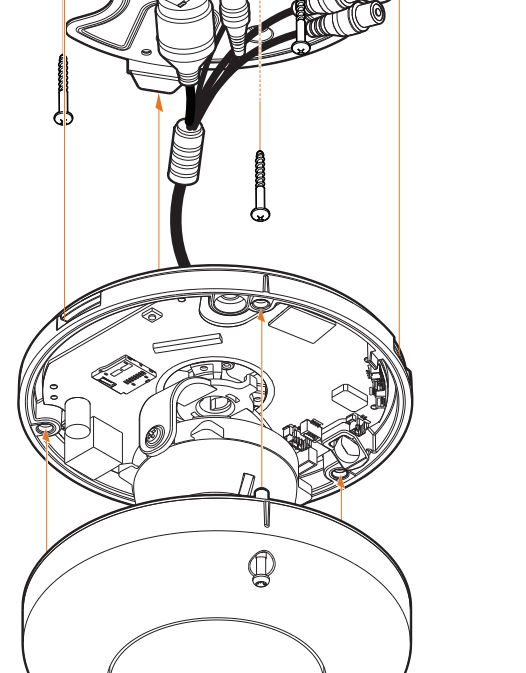

- Once the installation is complete, adjust the camera's tilt, panning and rotation as needed. The cameras' max angles are:
Pan: 0° - 360°, Tilt: 0° - 70°, Rotation: 0° - 360°
- Assemble the dome cover over the camera body and detach the protective film from the dome bubble.

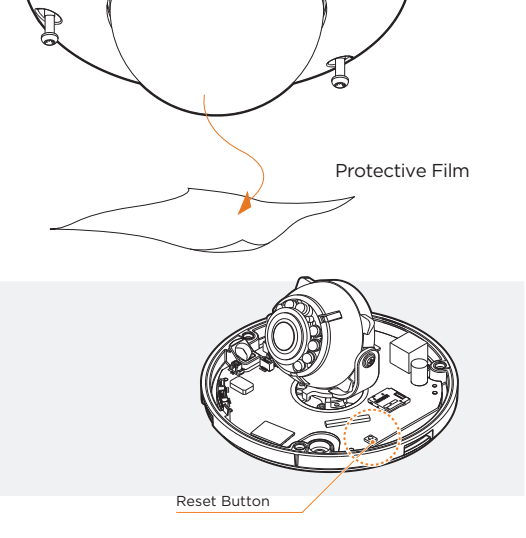

Resetting the camera: Press the reset button for five (5) seconds to initiate a camera-wide reset of all the settings, including network settings.

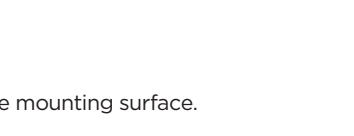

Installation using Mount Bolt and Screws:

- Using the mounting template, mark and drill the holes on the mounting surface.
- Secure the two long mounting screws to the camera's base.
- Pass the wires through the mount bracket and make all necessary connections.
- Mount the camera to the mounting surface by using the 2 mounting nuts. Rotate the locking discs over the screws until the camera is held tightly from the mounting surface.



STEP 4 - CABLING (DWC-MPF5Wi and DWC-MF5Wi series)

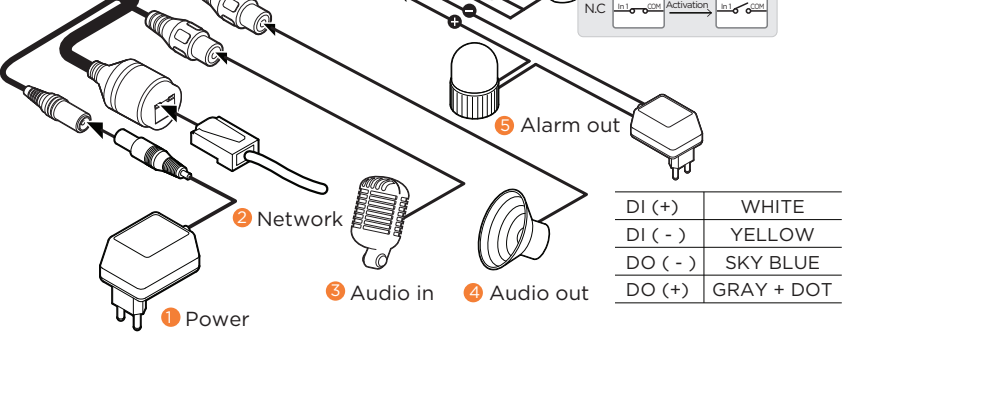

DI (+)	WHITE
DI (-)	YELLOW
DO (-)	SKY BLUE
DO (+)	GRAY + DOT

STEP 5 - MANAGING THE SD CARD

- Locate the SD card slot in the back of the camera module.
- Insert a class 10 SD card into the SD card slot by pressing the SD card slot.
- Remove the SD Card, press the card inward to release from the card slot.



NOTE: Maximum SD Card size supported: Up to 1TB micro SD / FAT32. When inserting the SD card into the card slot, the SD card's contacts should be facing upward, as shown in the diagram.

STEP 6 - DW® IP FINDER™

Use the DW IP Finder software to scan the network and detect all MEGAPIX® cameras, set the camera's network settings or access the camera's web client.

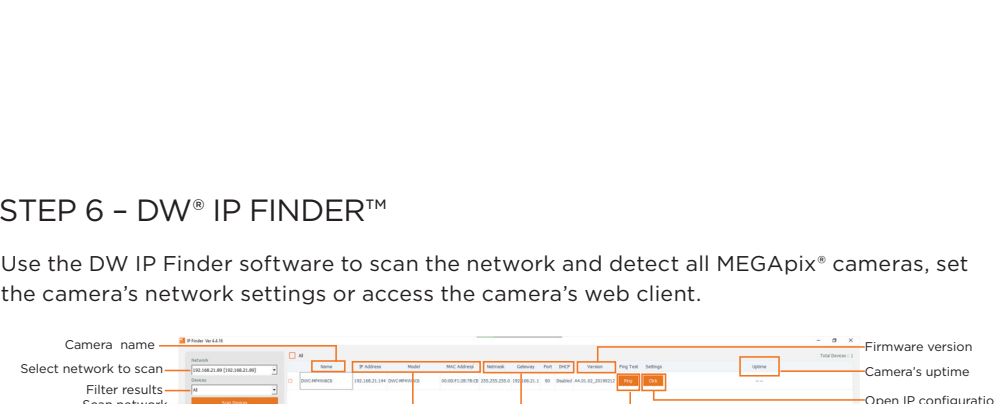

Network Setup

- To install the DW IP Finder, go to: <http://www.digital-watchdog.com>
- Enter "DW IP Finder" on the search box at the top of the page.
- Go to the "Software" tab on the DW IP Finder to download and install the installation file.

- Open the DW IP Finder and click 'Scan Devices'. It will scan the selected network for all supported devices and list the results in the table. During the scan, the DW® logo will turn gray.

- When connecting to the camera for the first time, a password must be set.
 - Check the box next to the camera in the IP Finder's search results. You can select multiple cameras.
 - Click "Bulk Password Assign" on the left.
 - Enter admin/admin for the current username and password. Enter a new username and password to the right.

Passwords must have a minimum of eight (8) characters and at least four (4) combinations of uppercase and lowercase letters, numbers and special characters. Passwords cannot contain the user ID.

- Click "change" to apply all changes.

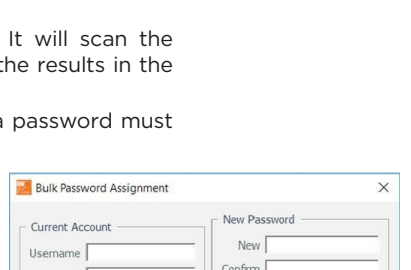

- Select a camera from the list by double-clicking on the camera's name or clicking on the 'Click' button. The pop-up window will show the camera's current network settings. Admin users can adjust the settings as needed. The camera's network settings are set to DHCP by default.

- To access the camera's web page, click on the 'Website' button.

- To save changes made to the camera's settings, enter the username and password of the camera's admin account and click 'Apply'.

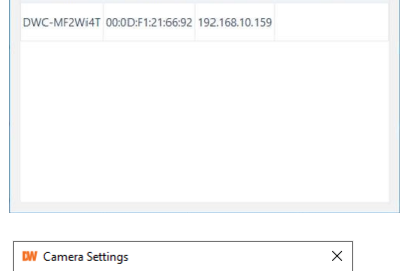

- Select 'DHCP' for the camera to automatically receive its IP address from the DHCP server.
- Select 'Static' to manually enter the camera's IP address, (Sub)Netmask, Gateway and DNS information.
- The camera's IP must be set to static if connecting to Spectrum® IPVMS.
- Contact your network administrator for more information.

- To access the camera from an external network, port forwarding must be set in your network's router.

STEP 7 - WEB VIEWER

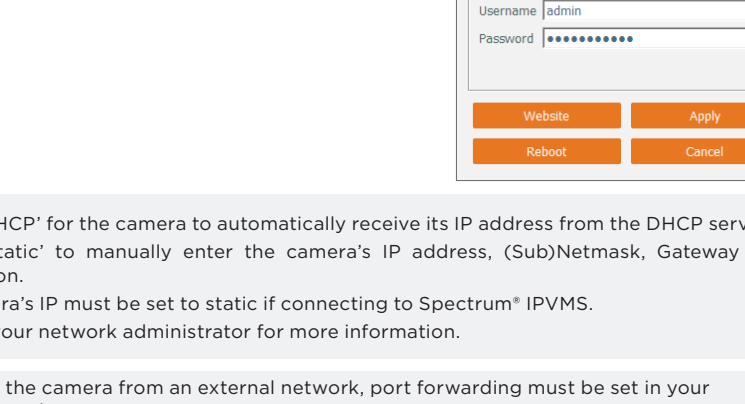

*The GUI display may differ by camera models.

- Find the camera using the DW IP Finder.
- Double-click on the camera's view in the results table.
- Press the 'View Camera Website'.
- Enter the camera's username and password you setup in the DW IP Finder. If you did not setup a new username and password, a message will direct you to setup a new password for the camera to view the video.

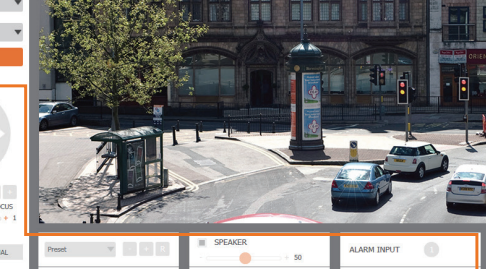

- When accessing the camera for the first time, install the VLC player for web files to view video from the camera.

NOTE: Please see the full product manual for web viewer setup, functions and camera settings options.

NOTE: This products is covered by one or more claims of the HEVC Patents listed at patentlist.coverageadvance.com.

